

EXPAND

DESIGN BY MARKSLÖJD
107517/107516

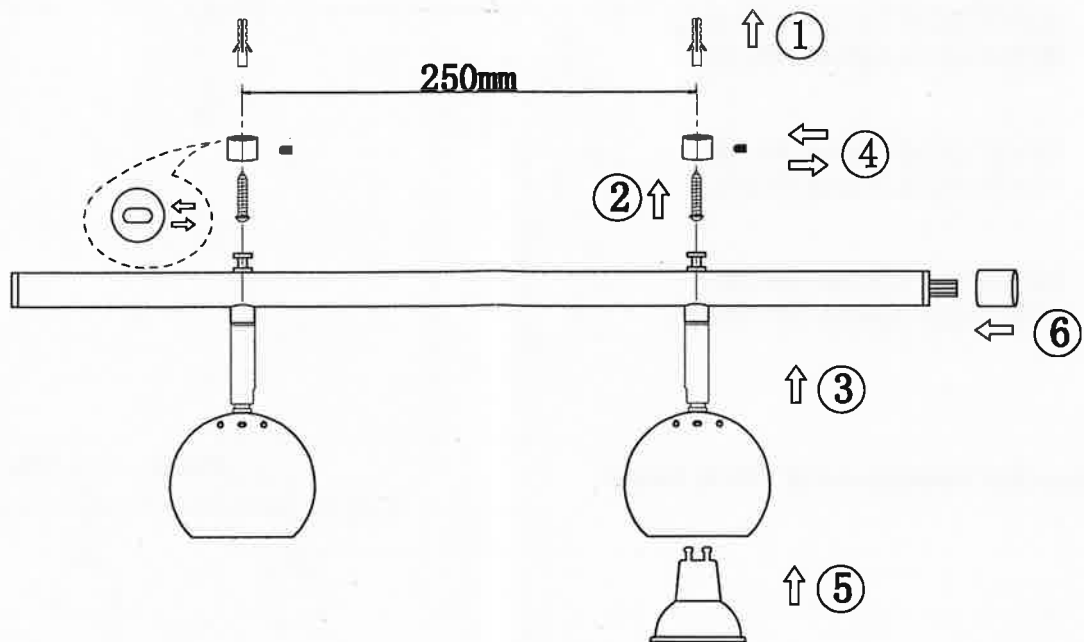

Markslöjd AB
Gränevägen 5 S-511 62 Skene
Sweden
www.markslöjd.com

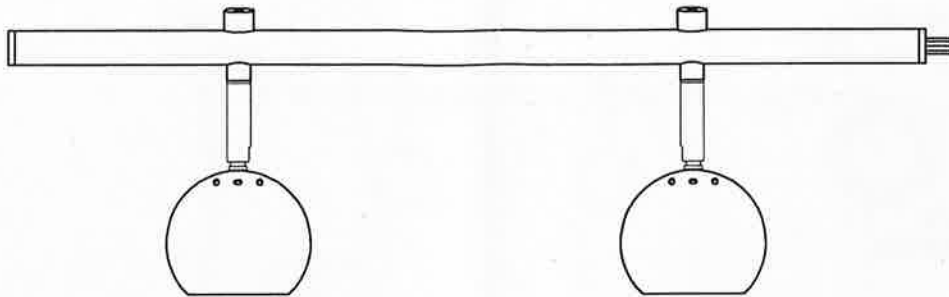

EXPAND

DESIGN BY MARKSLÖJD

107522/
107523 (a) →

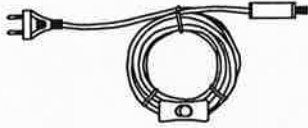

107520/
107521 (b) →

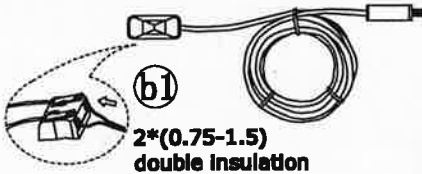

(b1)
2*(0.75-1.5)
double insulation

(d) 107517/107516..
etc. see below list →

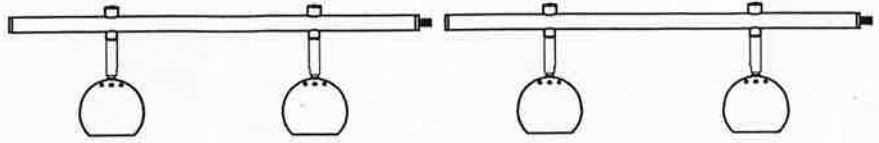

(c) 107519/
107518 →

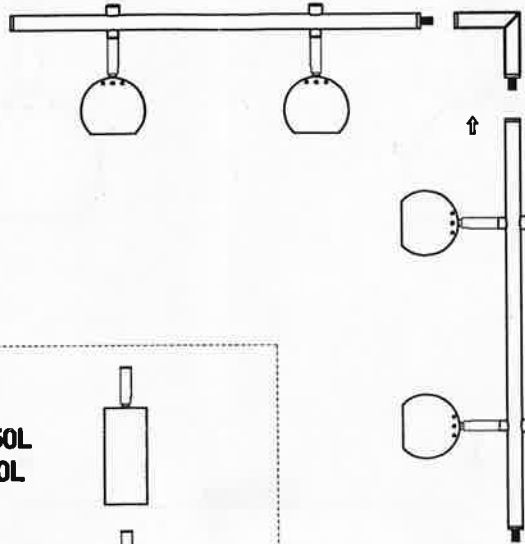

d: with different head or length

107515 GU10 Cylinder WH 50L
107514 GU10 Cylinder SN 50L

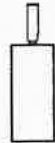

107517 GU10 Round WH 50L
107516 GU10 Round SN 50L



107510 E27 Cylinder SN 50L
107513 E27 Cylinder WH 50L



Important dimensions of drilling holes!

